

# Panel mounted control devices Ex9P1



- Panel mounted control devices
- Tested according to IEC / EN 60947-5-1
- Various operating head types
- Easy mounting into standard 22 mm panel cutout
- Degree of protection IP65
- Convenient mounting and demounting
- LED lamp units with high brightness
- Configurable system, arbitrary combination of head, contact and LED units for various applications

Panel mounted control devices line Ex9P1 are used in various control desks, operator panels or machine control circuit parts as well as for control functions in power distribution boards. They are designed as compact devices combined from various modular parts - operating head, basement, contact and illumination units. These parts can be freely combined to realize different functions.

For semi-transparent (illuminated) version there can be used LED unit with high brightness which ensures reliable indication of connected circuit, reduces power consumption and extends service life.

The operating heads are designed in bright colours and streamline surface. They are available in many various colours, shapes and types.

## Type Key

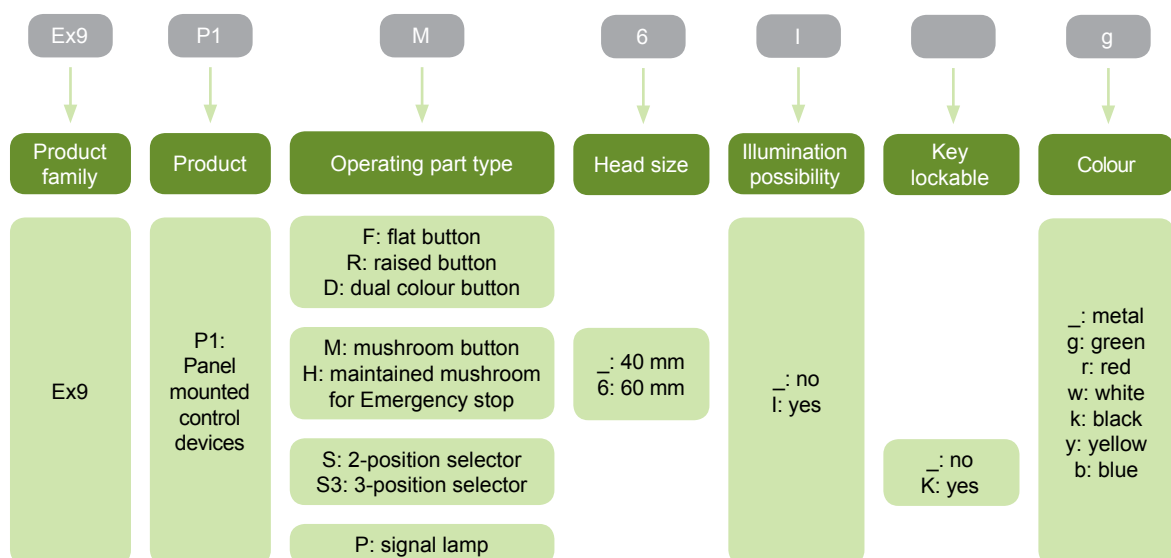

## Certification marks



# Panel mounted control devices Ex9P1

## Head types overview



## Mounting principle

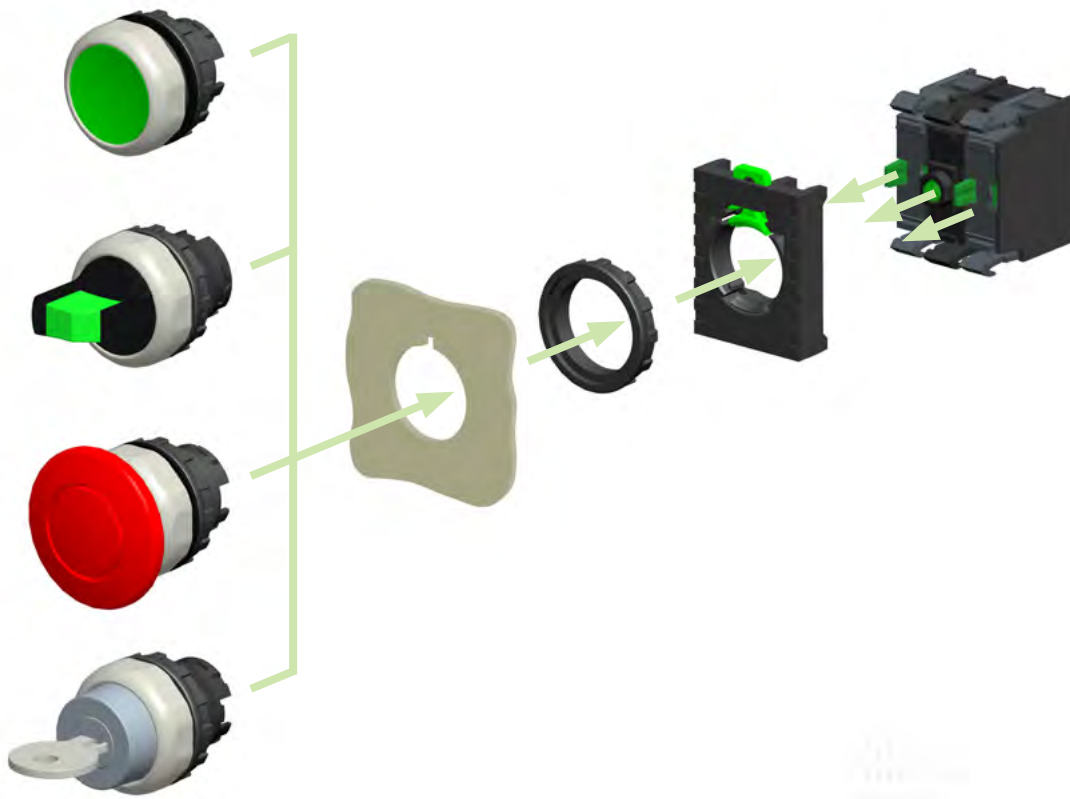

# Panel mounted control devices Ex9P1

## Flat buttons

- Momentary function
- Without printing on the head
- Function elements and basement to be ordered separately
- Scope of delivery: flat button head with aluminium cover ring



Colour	Illumination possibility	Article No.	Type	Packing
white	no	105612	Ex9P1 F w	1/20/360
black	no	105613	Ex9P1 F k	1/20/360
green	no	105614	Ex9P1 F g	1/20/360
red	no	105615	Ex9P1 F r	1/20/360
yellow	no	105616	Ex9P1 F y	1/20/360
blue	no	105617	Ex9P1 F b	1/20/360
clear	yes	105618	Ex9P1 FI w	1/20/360
green	yes	105619	Ex9P1 FI g	1/20/360
red	yes	105620	Ex9P1 FI r	1/20/360
yellow	yes	105621	Ex9P1 FI y	1/20/360
blue	yes	105622	Ex9P1 FI b	1/20/360

## Raised buttons

- Momentary function
- Without printing on the head
- Function elements and basement to be ordered separately
- Scope of delivery: raised button head with aluminium cover ring



Colour	Illumination possibility	Article No.	Type	Packing
white	no	105623	Ex9P1 R w	1/10/320
black	no	105624	Ex9P1 R k	1/10/320
green	no	105625	Ex9P1 R g	1/10/320
red	no	105626	Ex9P1 R r	1/10/320
yellow	no	105627	Ex9P1 R y	1/10/320
blue	no	105628	Ex9P1 R b	1/10/320
clear	yes	105629	Ex9P1 RI w	1/10/320
green	yes	105630	Ex9P1 RI g	1/10/320
red	yes	105631	Ex9P1 RI r	1/10/320
yellow	yes	105632	Ex9P1 RI y	1/10/320
blue	yes	105633	Ex9P1 RI b	1/10/320

# Panel mounted control devices Ex9P1

## Mushroom type buttons, 40 mm

- Momentary function
- Without printing on the head
- Function elements and basement to be ordered separately
- Scope of delivery: mushroom button head with aluminium cover ring



Colour	Illumination possibility	Article No.	Type	Packing
white	no	105634	Ex9P1 M w	1/10/210
black	no	105635	Ex9P1 M k	1/10/210
green	no	105636	Ex9P1 M g	1/10/210
red	no	105637	Ex9P1 M r	1/10/210
yellow	no	105638	Ex9P1 M y	1/10/210
blue	no	105639	Ex9P1 M b	1/10/210
clear	yes	105640	Ex9P1 MI w	1/10/210
green	yes	105641	Ex9P1 MI g	1/10/210
red	yes	105642	Ex9P1 MI r	1/10/210
yellow	yes	105643	Ex9P1 MI y	1/10/210
blue	yes	105644	Ex9P1 MI b	1/10/210

## Mushroom type buttons, 60 mm

- Momentary function
- Without printing on the head
- Function elements and basement to be ordered separately
- Scope of delivery: mushroom button head with aluminium cover ring



Colour	Illumination possibility	Article No.	Type	Packing
white	no	105645	Ex9P1 M6 w	1/5/90
black	no	105646	Ex9P1 M6 k	1/5/90
green	no	105647	Ex9P1 M6 g	1/5/90
red	no	105648	Ex9P1 M6 r	1/5/90
yellow	no	105649	Ex9P1 M6 y	1/5/90
blue	no	105650	Ex9P1 M6 b	1/5/90
clear	yes	105651	Ex9P1 M6I w	1/5/90
green	yes	105652	Ex9P1 M6I g	1/5/90
red	yes	105653	Ex9P1 M6I r	1/5/90
yellow	yes	105654	Ex9P1 M6I y	1/5/90
blue	yes	105655	Ex9P1 M6I b	1/5/90

# Panel mounted control devices Ex9P1

## Mushroom type buttons for Emergency stop

- Maintained function for emergency stop use (release by rotation)
- Function elements and basement to be ordered separately
- Scope of delivery: emergency stop mushroom head



Colour	Diameter	Illumination	Article No.	Type	Packing
red	40 mm	no	105656	Ex9P1 H r	1/10/210
red	60 mm	no	105657	Ex9P1 H6 r	1/5/90

## Emergency stop stickers

- Yellow colour, circular shape
- With opening for 22 mm panel mouted devices
- Various diameter and language variants (empty, with emergency stop symbol only, em. stop symbol with text in given language)
- Self-adhesive flexible plastic material printed from back side
- The language version defines language of the text „Emergency stop“

Diameter	Printing (language)	Article No.	Type	Packing	
60 mm	empty	107868	Ex9P1 H S6EMPTY	10	
	emergency stop symbol	107869	Ex9P1 H S6EMS	10	
	EN	106791	Ex9P1 H S6EN	10	
	CZ	106792	Ex9P1 H S6CZ	10	
	SK	106793	Ex9P1 H S6SK	10	
	PL	106794	Ex9P1 H S6PL	10	
	RO	106795	Ex9P1 H S6RO	10	
	DE	106796	Ex9P1 H S6DE	10	
	FR	106797	Ex9P1 H S6FR	10	
	ES	106798	Ex9P1 H S6ES	10	
	IT	106799	Ex9P1 H S6IT	10	
	RU	106800	Ex9P1 H S6RU	10	
	BG	106801	Ex9P1 H S6BG	10	
	RS	106802	Ex9P1 H S6RS	10	
60 mm	HU	106803	Ex9P1 H S6HU	10	
	LT	106804	Ex9P1 H S6LT	10	
	LV	106805	Ex9P1 H S6LV	10	
	EE	106806	Ex9P1 H S6EE	10	
	90 mm	empty	107870	Ex9P1 H S9EMPTY	10
		emergency stop symbol	107871	Ex9P1 H S9EMS	10
	90 mm	EN	106807	Ex9P1 H S9EN	10
		CZ	106808	Ex9P1 H S9CZ	10
		SK	106809	Ex9P1 H S9SK	10
		PL	106810	Ex9P1 H S9PL	10
		RO	106811	Ex9P1 H S9RO	10
		DE	106812	Ex9P1 H S9DE	10
		FR	106813	Ex9P1 H S9FR	10
		ES	106814	Ex9P1 H S9ES	10
IT		106815	Ex9P1 H S9IT	10	
RU		106816	Ex9P1 H S9RU	10	
BG		106817	Ex9P1 H S9BG	10	
RS		106818	Ex9P1 H S9RS	10	
HU		106819	Ex9P1 H S9HU	10	
LT		106820	Ex9P1 H S9LT	10	
LV		106821	Ex9P1 H S9LV	10	
EE		106822	Ex9P1 H S9EE	10	

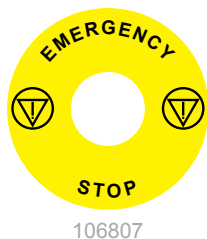
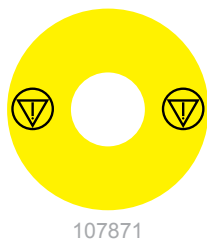

# Panel mounted control devices Ex9P1

## 2-position selector switches

- Rotary switch with handle
- 60° angle between positions
- Without printing on the head
- Function elements and basement to be ordered separately
- Scope of delivery: switch head with aluminium cover ring

### Maintained function types



Positions	Colour	Illumination possibility	Article No.	Type	Packing
2	white	no	105665	Ex9P1 S w	1/10/320
2	black	no	105666	Ex9P1 S k	1/10/320
2	green	no	105667	Ex9P1 S g	1/10/320
2	red	no	105668	Ex9P1 S r	1/10/320
2	yellow	no	105669	Ex9P1 S y	1/10/320
2	blue	no	105670	Ex9P1 S b	1/10/320
2	clear	yes	105671	Ex9P1 SI w	1/10/320
2	green	yes	105672	Ex9P1 SI g	1/10/320
2	red	yes	105673	Ex9P1 SI r	1/10/320
2	yellow	yes	105674	Ex9P1 SI y	1/10/320
2	blue	yes	105675	Ex9P1 SI b	1/10/320

### Momentary function types



Positions	Colour	Illumination possibility	Article No.	Type	Packing
2	white	no	105511	Ex9P1 SS w	1/10/320
2	black	no	105512	Ex9P1 SS k	1/10/320
2	green	no	105513	Ex9P1 SS g	1/10/320
2	red	no	105514	Ex9P1 SS r	1/10/320
2	yellow	no	105515	Ex9P1 SS y	1/10/320
2	blue	no	105516	Ex9P1 SS b	1/10/320
2	clear	yes	105517	Ex9P1 SSI w	1/10/320
2	green	yes	105518	Ex9P1 SSI g	1/10/320
2	red	yes	105519	Ex9P1 SSI r	1/10/320
2	yellow	yes	105520	Ex9P1 SSI y	1/10/320
2	blue	yes	105521	Ex9P1 SSI b	1/10/320

# Panel mounted control devices Ex9P1

## 3-position selector switches

- Rotary switch with handle
- 60° angle between positions
- Without printing on the head
- Function elements and basement to be ordered separately
- Scope of delivery: switch head with aluminium cover ring

### Maintained function types



Positions	Colour	Illumination possibility	Article No.	Type	Packing
3	white	no	105677	Ex9P1 S3 w	1/10/320
3	black	no	105678	Ex9P1 S3 k	1/10/320
3	green	no	105679	Ex9P1 S3 g	1/10/320
3	red	no	105680	Ex9P1 S3 r	1/10/320
3	yellow	no	105681	Ex9P1 S3 y	1/10/320
3	blue	no	105682	Ex9P1 S3 b	1/10/320
3	clear	yes	105683	Ex9P1 S3l w	1/10/320
3	green	yes	105684	Ex9P1 S3l g	1/10/320
3	red	yes	105685	Ex9P1 S3l r	1/10/320
3	yellow	yes	105686	Ex9P1 S3l y	1/10/320
3	blue	yes	105687	Ex9P1 S3l b	1/10/320

### Momentary function types



Positions	Colour	Illumination possibility	Article No.	Type	Packing
3	white	no	105522	Ex9P1 SS3 w	1/10/320
3	black	no	105523	Ex9P1 SS3 k	1/10/320
3	green	no	105524	Ex9P1 SS3 g	1/10/320
3	red	no	105525	Ex9P1 SS3 r	1/10/320
3	yellow	no	105526	Ex9P1 SS3 y	1/10/320
3	blue	no	105527	Ex9P1 SS3 b	1/10/320
3	clear	yes	105528	Ex9P1 SS3l w	1/10/320
3	green	yes	105529	Ex9P1 SS3l g	1/10/320
3	red	yes	105530	Ex9P1 SS3l r	1/10/320
3	yellow	yes	105531	Ex9P1 SS3l y	1/10/320
3	blue	yes	105532	Ex9P1 SS3l b	1/10/320

# Panel mounted control devices Ex9P1

## 3-position selector switches

- Rotary switch with handle
- 60° angle between positions
- Without printing on the head
- Function elements and basement to be ordered separately
- Scope of delivery: switch head with aluminium cover ring

### Maintained-momentary function types



Positions	Colour	Illumination possibility	Article No.	Type	Packing
3	white	no	105544	Ex9P1 SMS3 w	1/10/320
3	black	no	105545	Ex9P1 SMS3 k	1/10/320
3	green	no	105546	Ex9P1 SMS3 g	1/10/320
3	red	no	105547	Ex9P1 SMS3 r	1/10/320
3	yellow	no	105548	Ex9P1 SMS3 y	1/10/320
3	blue	no	105549	Ex9P1 SMS3 b	1/10/320
3	clear	yes	105550	Ex9P1 SMS3l w	1/10/320
3	green	yes	105551	Ex9P1 SMS3l g	1/10/320
3	red	yes	105552	Ex9P1 SMS3l r	1/10/320
3	yellow	yes	105553	Ex9P1 SMS3l y	1/10/320
3	blue	yes	105554	Ex9P1 SMS3l b	1/10/320

### Momentary-maintained function types



Positions	Colour	Illumination possibility	Article No.	Type	Packing
3	white	no	105533	Ex9P1 SSM3 w	1/10/320
3	black	no	105534	Ex9P1 SSM3 k	1/10/320
3	green	no	105535	Ex9P1 SSM3 g	1/10/320
3	red	no	105536	Ex9P1 SSM3 r	1/10/320
3	yellow	no	105537	Ex9P1 SSM3 y	1/10/320
3	blue	no	105538	Ex9P1 SSM3 b	1/10/320
3	clear	yes	105539	Ex9P1 SSM3l w	1/10/320
3	green	yes	105540	Ex9P1 SSM3l g	1/10/320
3	red	yes	105541	Ex9P1 SSM3l r	1/10/320
3	yellow	yes	105542	Ex9P1 SSM3l y	1/10/320
3	blue	yes	105543	Ex9P1 SSM3l b	1/10/320

# Panel mounted control devices Ex9P1

## 2-position selector switches with key

- Rotary switch with key
- 60° angle between positions
- The key can be removed in any maintained position
- Identical key for all ordered pieces
- Without printing on the head
- Function elements and base to be ordered separately
- Scope of delivery: switch head with aluminium cover ring, 2 keys

### Maintained function types



Positions	Article No.	Type	Packing
2	105676	Ex9P1 SK	1/10/320

### Momentary function types



Positions	Article No.	Type	Packing
2	105555	Ex9P1 SSK	1/10/320

# Panel mounted control devices Ex9P1

## 3-position selector switches with key

- Rotary switch with key
- 60° angle between positions
- The key can be removed in any maintained position
- Identical key for all ordered pieces
- Without printing on the head
- Function elements and basement to be ordered separately
- Scope of delivery: switch head with aluminium cover ring, 2 keys

### Maintained function types



Positions	Article No.	Type	Packing
3	105688	Ex9P1 S3K	1/10/320

### Momentary function types



Positions	Article No.	Type	Packing
3	105556	Ex9P1 SS3K	1/10/320

### Maintained-momentary function types



Positions	Maintained position	Article No.	Type	Packing
3	right	105557	Ex9P1 SSM3K	1/10/320
3	left	105558	Ex9P1 SMS3K	1/10/320

# Panel mounted control devices Ex9P1

## Dual colour buttons

- Momentary function
- Center (white) part illuminated and semi-transparent in Ex9P1 DI version
- Without printing on the head
- Function elements and basement to be ordered separately
- Scope of delivery: dual colour button head



Colour	Illumination possibility	Article No.	Type	Packing
green+red	no	105658	Ex9P1 D gr	1/10/120
green+red	yes	105659	Ex9P1 DI gr	1/10/120

## Signal lamps

- Various colour diffusion light lens
- Without printing on the head
- Function elements and basement to be ordered separately
- Scope of delivery: signal lamp head with aluminium cover ring



Colour	Article No.	Type	Packing
white	105660	Ex9P1 PI w	1/20/360
green	105661	Ex9P1 PI g	1/20/360
red	105662	Ex9P1 PI r	1/20/360
yellow	105663	Ex9P1 PI y	1/20/360
blue	105664	Ex9P1 PI b	1/20/360

## Basement

- Compatible with all control head types, contact and LED units
- Flush mounting
- Up to 3 contact units (or 2 contact + 1 LED units)
- Allows to combine device heads with function elements



Description	Article No.	Type	Packing
Basement for 3 units	105611	Ex9P1 B3	1/60/1080

## Part for middle contact unit control

- Inserted into the head for control of the middle contact unit (instead of LED unit)
- Suitable for Ex9P1 F\*, R\*, M\* control head types with illumination possibility



Description	Article No.	Type	Packing
Part for middle contact control	105580	Ex9P1 MC	1/60/1080

# Panel mounted control devices Ex9P1

## Contact units

- Single contact units
- Normally open (NO) or normally close (NC) internal contact version
- Control moving part colour according to internal contact type
- For flush mounting type basement
- Arbitrary position in the basement, central position block must to be used with Ex9P1 MC part (see technical parameters)



Contact	Colour	Article No.	Type	Packing
1 NO	green	105578	Ex9P1 1NO	1/90/1620
1 NC	red	105579	Ex9P1 1NC	1/90/1620

## LED units

- Various colour and rated voltage versions
- To be installed to the middle position in the basement
- Suitable for all illuminated control head types
- For flush mounting type basement



Colour	Rated voltage	Article No.	Type	Packing
white	6 V AC/DC	105581	Ex9P1 LEDw 6V AC/DC	1/60/1080
white	12 V AC/DC	105582	Ex9P1 LEDw 12V AC/DC	1/60/1080
white	24 V AC/DC	105583	Ex9P1 LEDw 24V AC/DC	1/60/1080
white	36 V AC/DC	105584	Ex9P1 LEDw 36V AC/DC	1/60/1080
white	110-230 V AC/DC	105585	Ex9P1 LEDw 110V-230V AC	1/60/1080
red	6 V AC/DC	105587	Ex9P1 LEDr 6V AC/DC	1/60/1080
red	12 V AC/DC	105588	Ex9P1 LEDr 12V AC/DC	1/60/1080
red	24 V AC/DC	105589	Ex9P1 LEDr 24V AC/DC	1/60/1080
red	36 V AC/DC	105590	Ex9P1 LEDr 36V AC/DC	1/60/1080
red	110-230 V AC/DC	105591	Ex9P1 LEDr 110V-230V AC	1/60/1080
green	6 V AC/DC	105593	Ex9P1 LEDg 6V AC/DC	1/60/1080
green	12 V AC/DC	105594	Ex9P1 LEDg 12V AC/DC	1/60/1080
green	24 V AC/DC	105595	Ex9P1 LEDg 24V AC/DC	1/60/1080
green	36 V AC/DC	105596	Ex9P1 LEDg 36V AC/DC	1/60/1080
green	110-230 V AC/DC	105597	Ex9P1 LEDg 110V-230V AC	1/60/1080
yellow	6 V AC/DC	105599	Ex9P1 LEDy 6V AC/DC	1/60/1080
yellow	12 V AC/DC	105600	Ex9P1 LEDy 12V AC/DC	1/60/1080
yellow	24 V AC/DC	105601	Ex9P1 LEDy 24V AC/DC	1/60/1080
yellow	36 V AC/DC	105602	Ex9P1 LEDy 36V AC/DC	1/60/1080
yellow	110-230 V AC/DC	105603	Ex9P1 LEDy 110V-230V AC	1/60/1080
blue	6 V AC/DC	105605	Ex9P1 LEDb 6V AC/DC	1/60/1080
blue	12 V AC/DC	105606	Ex9P1 LEDb 12V AC/DC	1/60/1080
blue	24 V AC/DC	105607	Ex9P1 LEDb 24V AC/DC	1/60/1080
blue	36 V AC/DC	105608	Ex9P1 LEDb 36V AC/DC	1/60/1080
blue	110-230 V AC/DC	105609	Ex9P1 LEDb 110V-230V AC	1/60/1080

# Panel mounted control devices Ex9P1

## Position and function description labels

- Various versions of labels
- Holder and labels to be ordered separately
- Silver plastic material of stickers
- Self-adhesive - can be stuck onto the holder or inserted underneath of transparent cover
- Printing colour of standard and customer defined labels: black
- Customer defined variants of labels (ordering quantity as multiple of 7 pcs, printing can be different for every single piece)\*



Description	Article No.	Type	Packing
Holder for labels	106776	Ex9P1 S SH	1
<b>Label printing</b>			
Empty label (25x11 mm)	106777	Ex9P1 S S0	10
OFF - ON	106778	Ex9P1 S S1	10
0 - I	106779	Ex9P1 S S2	10
I - 0 - II	106780	Ex9P1 S S3	10
STOP - START	106781	Ex9P1 S S4	10
0 - 1	106782	Ex9P1 S S5	10
1 - 0 - 2	106783	Ex9P1 S S6	10
STOP	106784	Ex9P1 S S7	10
START	106785	Ex9P1 S S8	10
ON	106786	Ex9P1 S S9	10
OFF	106787	Ex9P1 S S10	10
RUN	106788	Ex9P1 S S11	10
AUTO	106789	Ex9P1 S S12	10
FAULT	106790	Ex9P1 S S13	10
Customer defined printing*	107876	Ex9P1 S S_USER	7

### *\*) Ordering of customer defined stickers:*

- Order the item 107876
- Attach the information with requested sticker text and quantity of stickers with given content. Each sticker can be different
- Minimum ordering quantity is 7 pieces and multiples
- In case of graphic symbol to be produced, it is necessary to deliver source data (pdf, ai, jpg, png, etc.)
- Mention positioning of the sticker (standard horizontal, vertical)
- Maximum printable area is 10 x 24 mm (H x W)

# Technical Data Ex9P1

## Panel mounted control devices

### General parameters

For various control desks, operator panels or machine control circuit parts applications as well as for control functions in power distribution boards

Various control head types with aluminium cover ring

Arbitrary combination of head, contact and LED units for various applications

### Electrical parameters - contact and LED units

	Ex9P1 1NO	Ex9P1 1NC	Ex9P1 LED
Tested according to	IEC / EN 60947-5-1		
Rated operational voltage $U_e$	120, 240, 415 V AC (AC-15) 125, 250 V DC (DC-13)		6, 12, 24, 36, 110 - 230 V AC/DC
Rated operational current $I_e$ AC-15	6 A at 120 V AC 3 A at 240 V AC 1.9 A at 415 V AC		≤ 20 mA
DC-13	0.55 A at 125 V DC 0.27 A at 250 V DC		
Rated frequency f	50/60 Hz		
Rated impulse withstand voltage $U_{imp}$	4 kV	4 kV	—
Rated insulation voltage $U_i$	690 V	690 V	415 V
Utilization category	AC-15, DC-13		—
Electrical service life	1 000 000 operation cycles at AC 250 000 operation cycles at DC		> 30 000 hours
Power consumption	—	—	≤ 1.05 W
Max. short-circuit protection device	16 A gG		

### Mechanical parameters - contact and LED units

	Ex9P1 1NO	Ex9P1 1NC	Ex9P1 LED
Mounting	front mounting onto Ex9P1 B3 basement		
Mounting position	arbitrary		
Degree of protection	IP20		
Terminals	lift		
Terminal capacity	0.5 — 2.5 mm <sup>2</sup>		
Fastening torque of terminals	0.8 Nm		
Mechanical service life	3 000 000 operation cycles		—
Max. switching frequency	3 600 per hour		—
Ambient temperature	-5 — +40 °C		
Altitude	≤ 2000 m		
Relative humidity	≤ 90 % at 20°C		
Pollution degree	3		
Installation class	II		
Comparative tracking index CTI	175 V		
Shock IEC 60068-2-27	15 g (half sine 11 ms)		
Vibration IEC 60068-2-6	10-55 Hz, 0.5 mm		

# Technical Data Ex9P1

## Panel mounted control devices

### Wiring diagrams

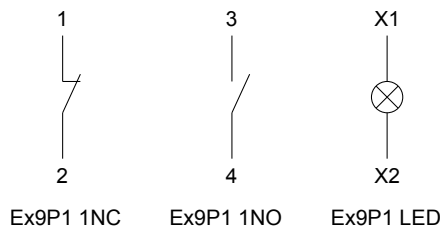

### Mechanical parameters - control heads

	Ex9P1 F	Ex9P1 R	Ex9P1 D	Ex9P1 M
Mounting	into standard 22 mm panel cutout			
Mounting position	arbitrary			
Degree of protection	IP65 (mounted)			
Operation power	30 N	30 N	30 N	50 N
Operation torque	—	—	—	—
Mechanical service life	3 000 000 operation cycles	3 000 000 operation cycles	100 000 operation cycles	3 000 000 operation cycles
Max. switching frequency	3 600 per hour	3 600 per hour	2 400 per hour	3 600 per hour
Ambient temperature	-5 — +40 °C			
Altitude	≤ 2000 m			
Relative humidity	≤ 90 % at 20°C			
Pollution degree	3			
Installation class	II			

### Mechanical parameters - control heads

	Ex9P1 H	Ex9P1 S	Ex9P1 SK	Ex9P1 P
Mounting	into standard 22 mm panel cutout			
Mounting position	arbitrary			
Degree of protection	IP65 (mounted)			
Operation power	50 N	—	—	—
Operation torque	0.6 Nm	0.5 Nm	0.5 Nm	—
Mechanical service life	100 000 operation cycles	100 000 operation cycles	100 000 operation cycles	—
Max. switching frequency	1 200 per hour	1 200 per hour	1 200 per hour	—
Ambient temperature	-5 — +40 °C			
Altitude	≤ 2000 m			
Relative humidity	≤ 90 % at 20°C			
Pollution degree	3			
Installation class	II			

# Technical Data Ex9P1

## Panel mounted control devices

### Dimensions (complete devices)

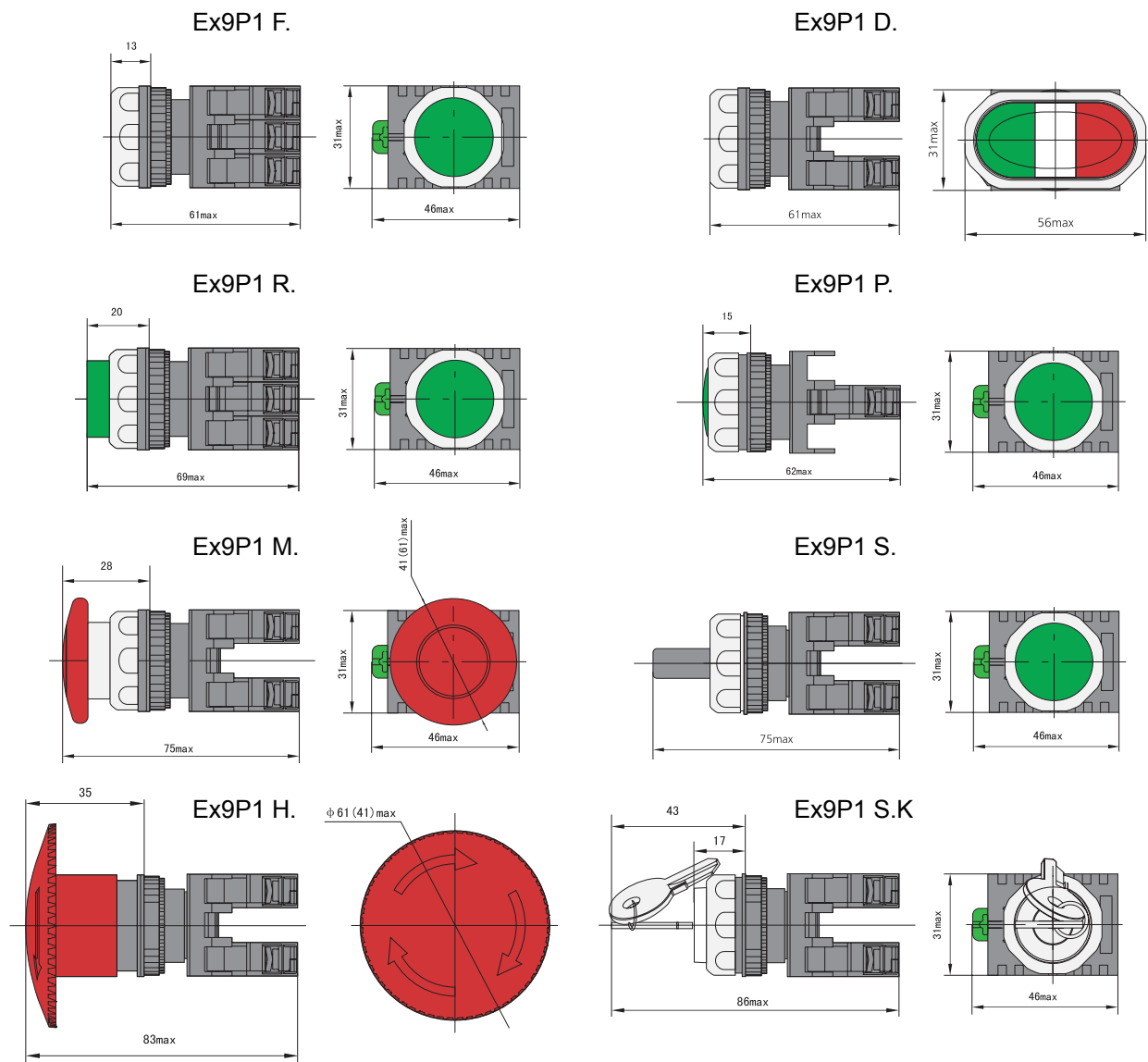

### Dimensions (holder for labels)

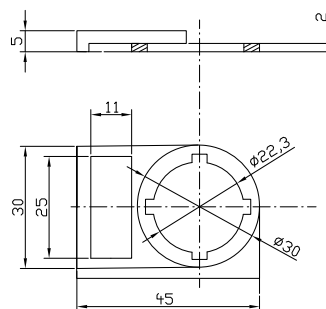

# Technical Data Ex9P1

## Panel mounted control devices

### Mounting dimensions

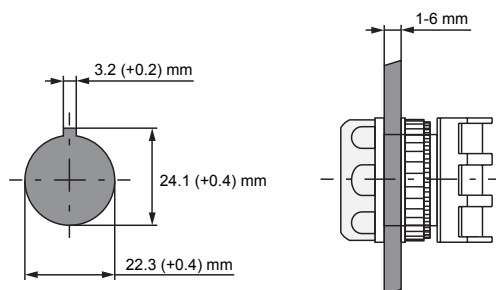

### Mounting principle

